

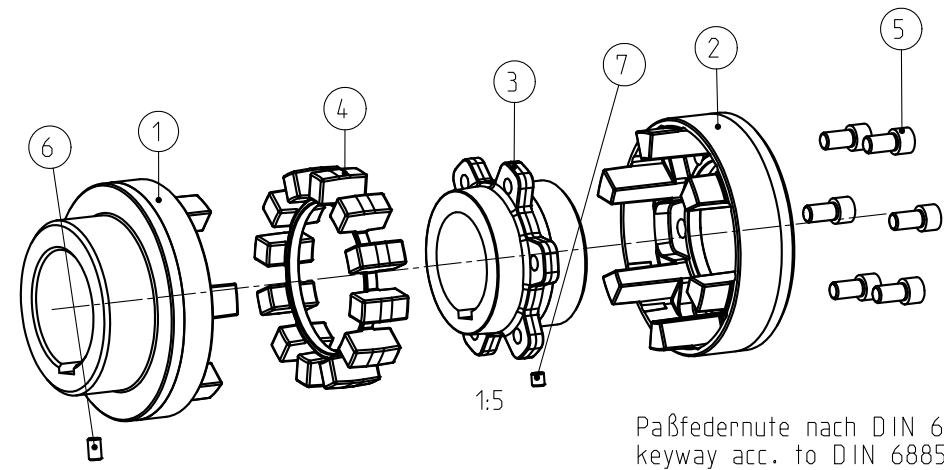

Drehmoment / Torque
 Elastomerring / elastomer ring
 NBR 78 Shore A
 $T_{KN} = 2900 \text{ Nm}$
 $T_{Kmax} = 5800 \text{ Nm}$

POLY-NORM	Gewicht weight (kg)	Massenträgheitsmoment mass moment of inertia (kgm ²)
Kupplungshälfte Teil 1 coupling half part 1	11.952	0.0796903
Kupplungshälfte Teil 2+3+5 coupling half part 2+3+5	13.534	0.0917779
Elastomerring Teil 4 elastomer ring part 4	0.512	0.0041060
Komplette Kupplung complete coupling	25.998	0.1755760



Paßfedernute nach DIN 6885 Bl. 1-JS9
 keyway acc. to DIN 6885 sheet 1-JS9

Schraubenanzugsmoment Teil 5 / screw tightening torque part 5
 DIN EN ISO 4762 - M16x30 - 12.9; $T_A = 210 \text{ Nm}$

Oberflächengüte nach DIN ISO 1302 Reihe 2 Surface quality acc. to DIN ISO 1302 line 2		Schutzvermerk ISO 16016 beachten Note protection mark acc. to ISO 16016			
Allgemeintoleranzen nach DIN ISO 2768 - mH General tolerances acc. to DIN ISO 2768-		Masstab Scale	7:20	Format DIN Size	A3
POLY-NORM 100 Ø110 Ø95 Bauart ADR			 KTR-Kupplungstechnik GmbH D-48407 Rheine		
gezeichnet drawn	Werkstoff Material	Teilnummer Part number	Kz	Lfd.-Nr. Current number	Index Change
Datum 13.10.11	DIN		M	403526	4
Name LUH	Gewicht Weight	25.998			