

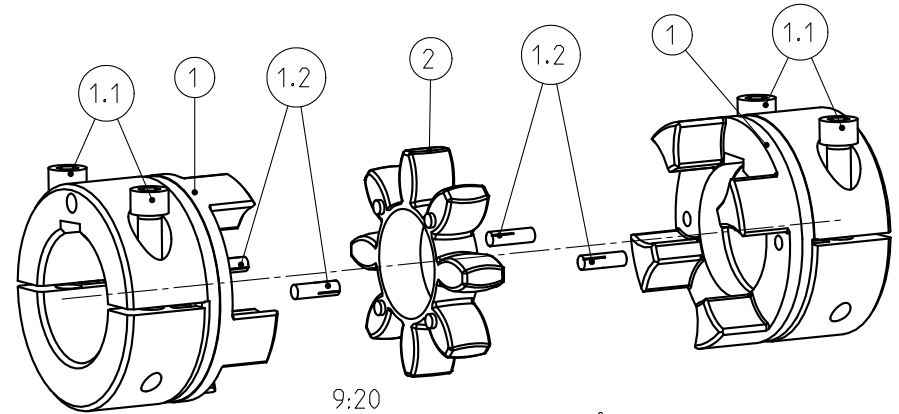

Massenträgheitsmoment / Mass moment of inertia
 $J_{ges.} = 0.00579932 \text{ kgm}^2$

Drehmoment / Torque
 Zahnkranz / spider 92 Sh A T-PUR
 (Zahnkranz / spider 92 Sh A)
 $T_{KN} = 265 \text{ Nm}$
 $T_{Kmax} = 530 \text{ Nm}$



Paßfedernute nach DIN 6885 Bl. 1-JS9
 keyway acc. to DIN 6885 sheet 1-JS9

Schraubenanzugsmoment Teil 1.1 M10x35 DIN 912-12.9, $T_A = 69 \text{ Nm}$
 screw tightening torque part 1.1 M10x35 DIN 912-12.9, $T_A = 69 \text{ Nm}$

Oberflächengüte nach DIN ISO 1302 Reihe 2 Surface quality acc. to DIN ISO 1302 line 2		Schutzvermerk ISO 16016 beachten Note protection mark acc. to ISO 16016			
Allgemeintoleranzen nach DIN ISO 2768 - mH General tolerances acc. to DIN ISO 2768-		Masstab Scale	4:5	Format DIN Size	A3
ROTEX 42 A-H			 KTR-Kupplungstechnik GmbH D-48407 Rheine		
gezeichnet drawn	Werkstoff Material	Teilnummer Part number	Kz	Lfd.-Nr. Current number	Index Change
Datum 09.01.12	DIN		M	424731	1
Name SCHP	Gewicht Weight	3.828			