

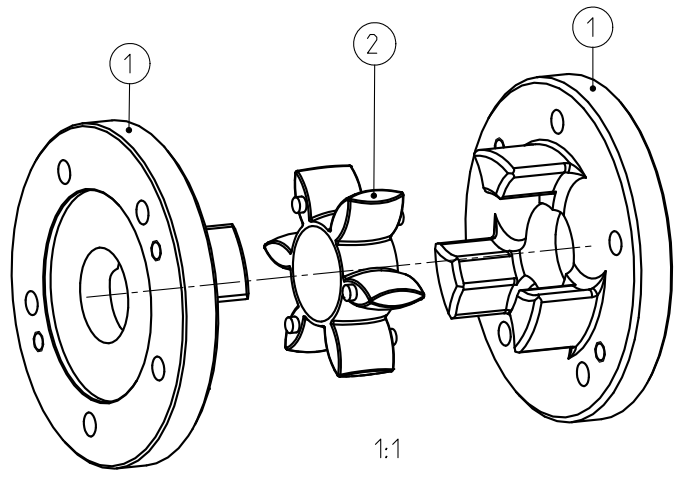

Drehmoment / Torque
 Zahnkranz / spider 92 Sh A T-PUR
 (Zahnkranz / spider 92 Sh A)
 $T_{KN} = 10 \text{ Nm}$
 $T_{Kmax} = 20 \text{ Nm}$



Massenträgheitsmoment / Mass moment of inertia
 $J_{ges.} = 0.00020344715 \text{ kgm}^2$

Oberflächengüte nach DIN ISO 1302 Reihe 2 Surface quality acc. to DIN ISO 1302 line 2		Schutzvermerk ISO 16016 beachten Note protection mark acc. to ISO 16016			
Allgemeintoleranzen nach DIN ISO 2768 - mH General tolerances acc. to DIN ISO 2768 - mH		Masstab Scale	3:2	Format DIN Size	A3
ROTEX 19 DF			 KTR-Kupplungstechnik GmbH D-48407 Rheine		
gezeichnet drawn	Werkstoff Material	Teilnummer Part number	Kz	Lfd.-Nr. Current number	Index Change
Datum 20.01.12	DIN		M	424910	1
Name SCHP	Gewicht Weight	0.378			