

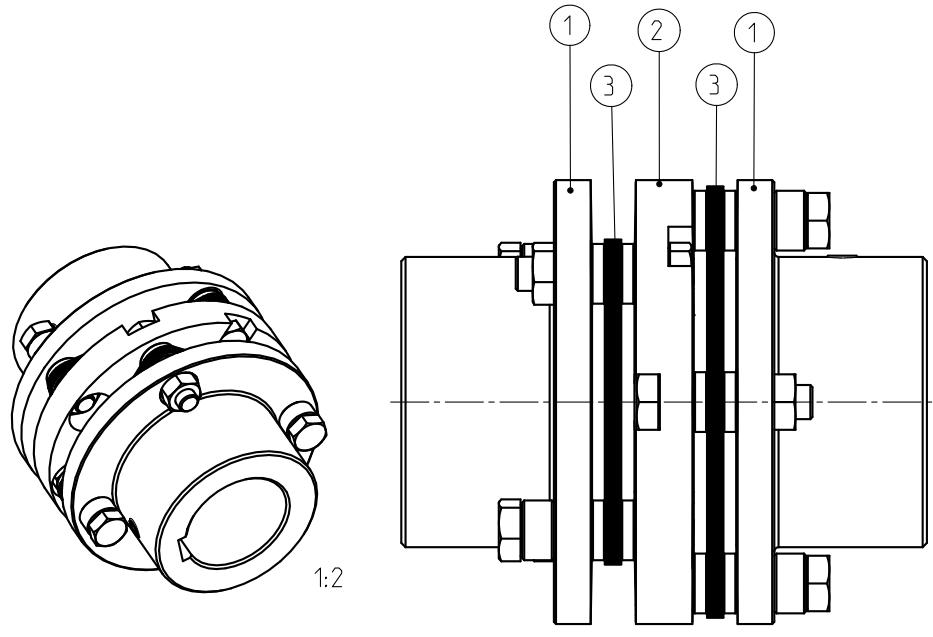

Achtung bei der Montage!
Lage des Lamellenpaketes beachten!
Buchse liegt an der Nabe an!



Oberflächengüte nach DIN ISO 1302 Reihe 2 Surface quality acc. to DIN ISO 1302 line 2			Schutzvermerk ISO 16016 beachten Note protection mark acc. to ISO 16016			
Allgemeintoleranzen nach DIN ISO 2768 - General tolerances acc. to DIN ISO 2768-			Masstab Scale	9:10	Format DIN Size	A3
RADEX-N 42 NNZ			 KTR-Kupplungstechnik GmbH D-48407 Rheine			
gezeichnet drawn	Werkstoff Material		Teilnummer Part number	Kz	Lfd.-Nr. Current number	Index Change
Datum 13.10.09	DIN			M	398078	4
Name KU	Gewicht Weight	3.147				